

**PowerCool Series Thermoelectric Cooler Assembly**

The AA-100-24-22 is an Air-to-Air Thermoelectric Cooler Assembly that uses impingement flow to transfer heat. It offers dependable, compact performance by cooling objects via convection. Heat is absorbed and dissipated through high density heat exchangers equipped with air ducted shrouds and brand name fans. The heat pumping action is created by thermoelectric modules, which are custom designed to achieve a high coefficient of performance (COP). It has a maximum Qc of 102 Watts when  $\Delta T = 0$  and a maximum  $\Delta T$  of 45 °C at Qc = 0.

**Features**

- Compact design
- Precise temperature control
- Reliable solid-state operation
- Low noise
- RoHS-compliant

**Applications**

- Medical Diagnostic and Analytical Instrumentation
- Thermoelectric Coolers and Assemblies for Medical Applications
- Liquid Cooling Options for PET and SPECT Scanners
- Cooling for Centrifuges
- High-Performance Liquid Chromatography (HPLC)
- Heating and Cooling for Liquid Chromatography Systems

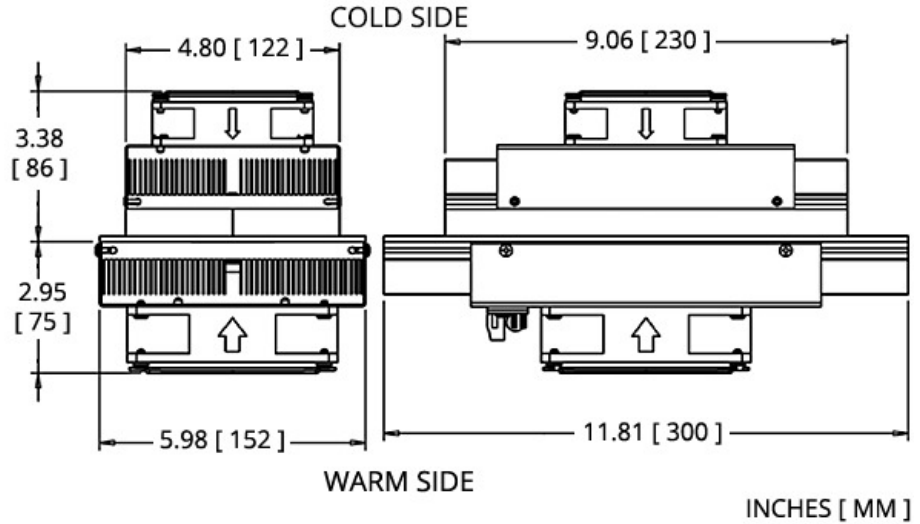
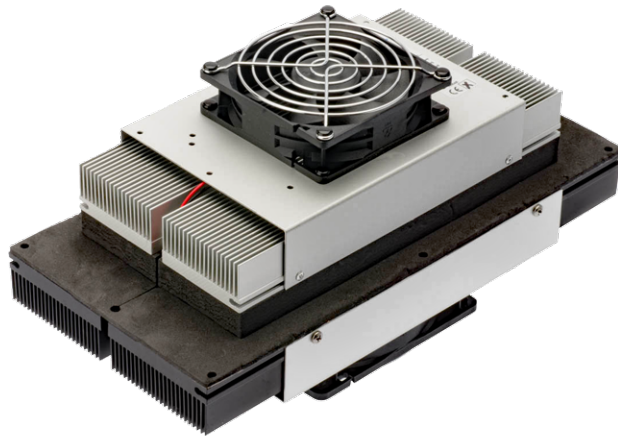

**ELECTRICAL AND THERMAL PERFORMANCE**

Heat Pumped at Cold Side (Qc)  
 Tambient = 35°C | Tcontrol = 20°C

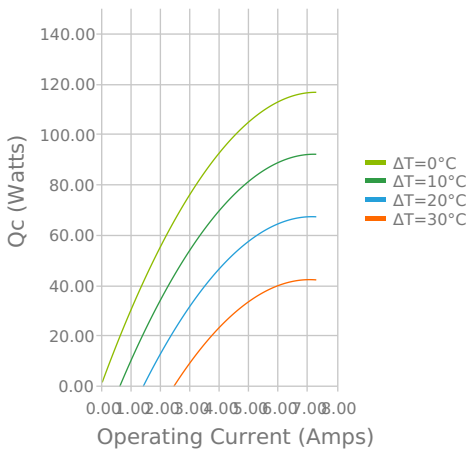

Heat Pumped at Cold Side (Qc)  
 Tambient = 35°C | Tcontrol = 20°C

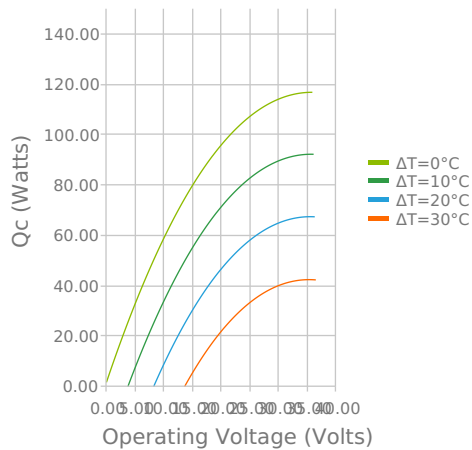

Coefficient of Performance (COP = Qc/Pin)  
 Tambient = 35°C | Tcontrol = 20°C

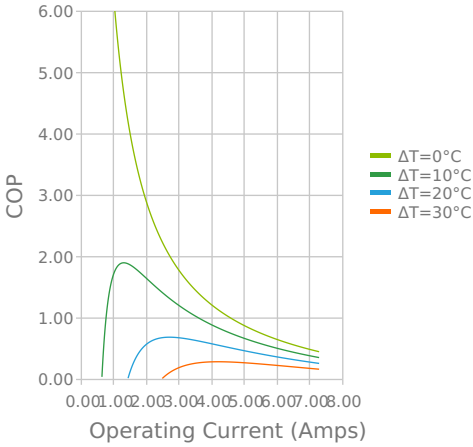

Coefficient of Performance (COP = Qc/Pin)  
 Tambient = 35°C | Tcontrol = 20°C

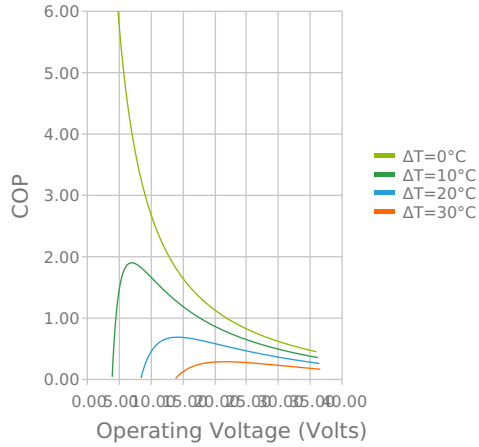

Total Heat Dissipated at Hot Side (Qh=Qc+Pin)  
 Tambient = 35°C | Tcontrol = 20°C

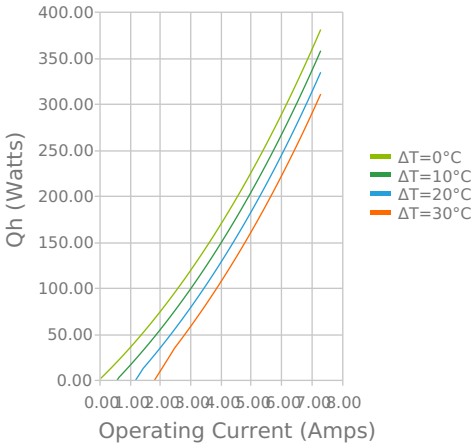

Total Heat Dissipated at Hot Side (Qh=Qc+Pin)  
 Tambient = 35°C | Tcontrol = 20°C

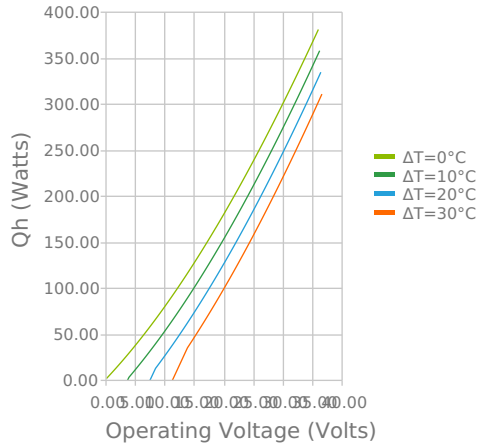

Heat Pumped at Cold Side (Qc)  
 Voperating = 24.01 Volts | Ioperating = 5.01 Amps

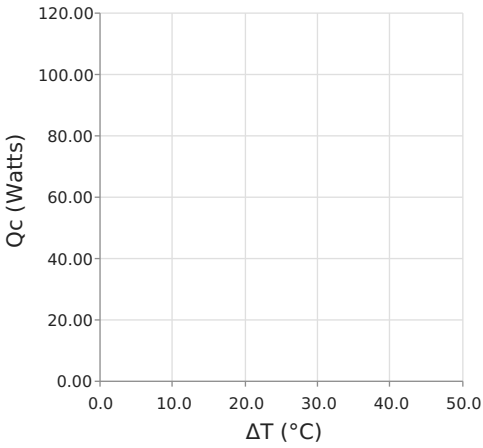

Coefficient of Performance (COP = Qc/Pin)  
 Voperating = 24.01 Volts | Ioperating = 5.01 Amps

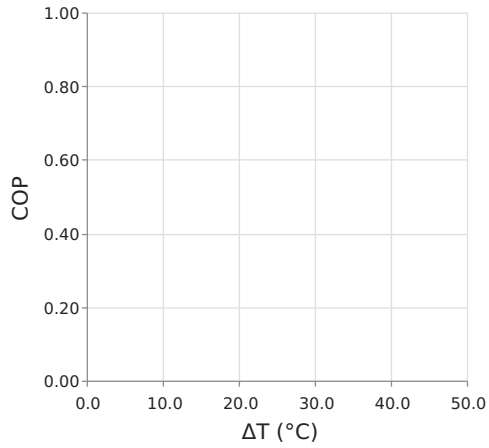

**SPECIFICATIONS**

- Operating Temperature Range**
- Supply Voltage**
- Current Draw**
- Power Supply**
- Performance Tolerance**
- Fan MTBF**
- Weight**

-10°C to 50°C
24.0 VDC nominal / 30.0 VDC maximum
5.6 A running / 6.6 A startup
134.0 Watts
10%
40,000 hours
4.00 kg

**MOUNTING HOLE LOCATION**

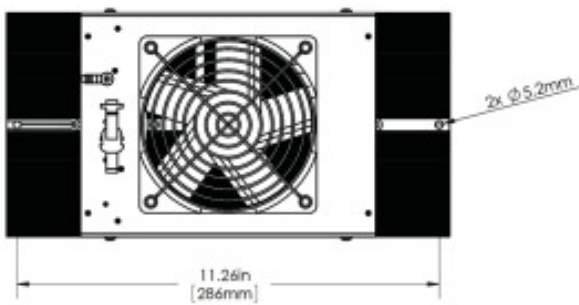

**WIRING SCHEMATIC**

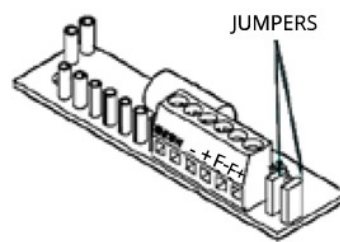

**ELECTRICAL CONNECTIONS:**  
 "+": + TEM  
 "-": - TEM  
 "F+": + FAN(S)  
 "F-": - FAN(S)

To use single supply:  
 Lift the jumpers and rotate 90° to short-out the pin pairs.  
 Connect the unit to "+" & "-".

**Warning: Single supply not applicable in heating mode or with PWM-regulation.**

**NOTES**

<sup>1</sup>For indoor use only

<sup>2</sup>Units are generally maintenance free, however occasionally it is recommended to clean the heat sinks and fans of debris. This is best done with compressed air.

Any information furnished by Laird and its agents, whether in specifications, data sheets, product catalogues or otherwise, is believed to be (but is not warranted as being) accurate and reliable, is provided for information only and does not form part of any contract with Laird. All specifications are subject to change without notice. Laird assumes no responsibility and disclaims all liability for losses or damages resulting from use of or reliance on this information. All Laird products are sold subject to the Laird Terms and Conditions of sale (including Laird's limited warranty) in effect from time to time, a copy of which will be furnished upon request.

© Copyright 2019-2021 Laird Thermal Systems, Inc. All rights reserved. Laird<sup>™</sup>, the Laird Ring Logo, and Laird Thermal Systems<sup>™</sup> are trademarks or registered trademarks of Laird Limited or its subsidiaries.

Date: 06/08/2021