

Liquid Series Thermoelectric Cooler Assembly

The DL-060-12-00 thermoelectric cooler assembly offers dependable, compact performance by cooling objects via liquid to transfer heat. Heat is absorbed through a cold block and dissipated thru a second liquid heat exchanger. The thermoelectric modules are custom designed to achieve a high coefficient of performance (COP) to minimize power consumption. It has a maximum Qc of 65 Watts when $\Delta T = 0$ and a maximum ΔT of 42 °C at Qc = 0. The liquid heat exchanger is designed to accommodate distilled water with glycol. Corrosion resistant turbulators are enclosed inside channels to increase heat transfer. Mating port adaptors are sold separately.

Features

- Compact design
- Precise temperature control
- Reliable solid-state operation
- DC operation
- RoHS-compliant

Applications

- Medical Diagnostics
- Industrial Lasers
- Medical Lasers
- Analytical Instrumentation

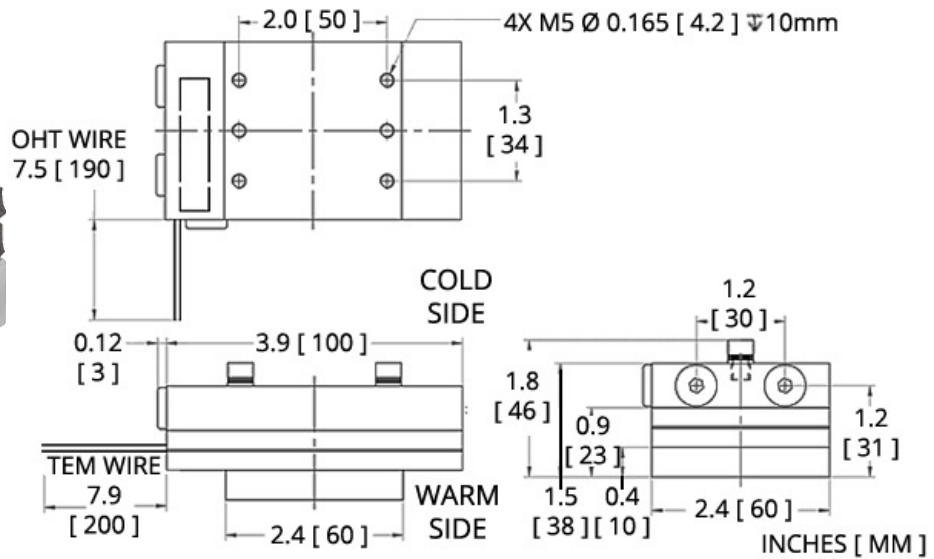
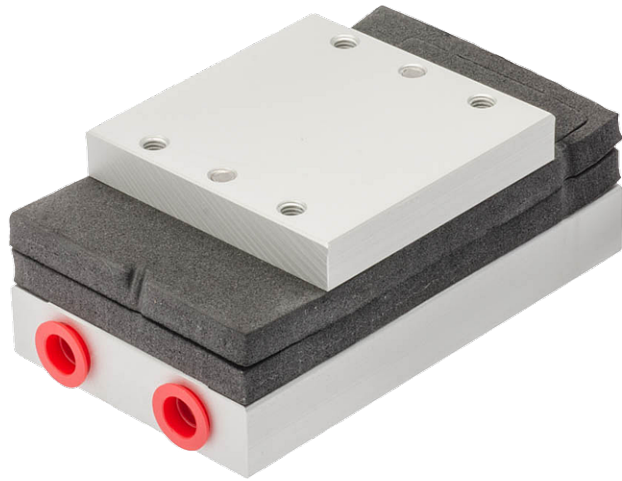

ELECTRICAL AND THERMAL PERFORMANCE

Heat Pumped at Cold Side (Qc)
 Tambient = 35°C | Tcontrol = 20°C

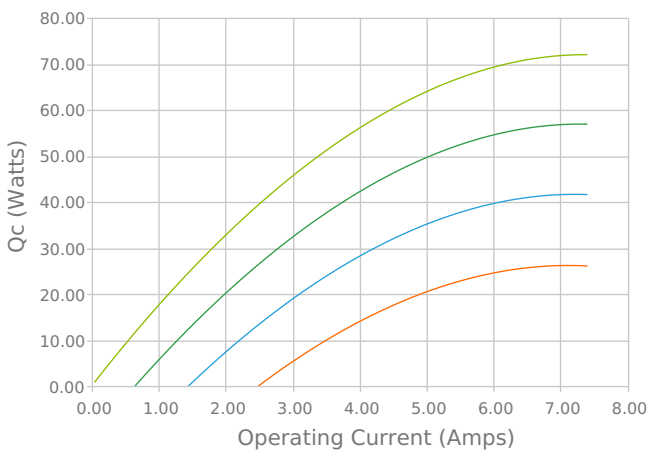

Heat Pumped at Cold Side (Qc)
 Tambient = 35°C | Tcontrol = 20°C

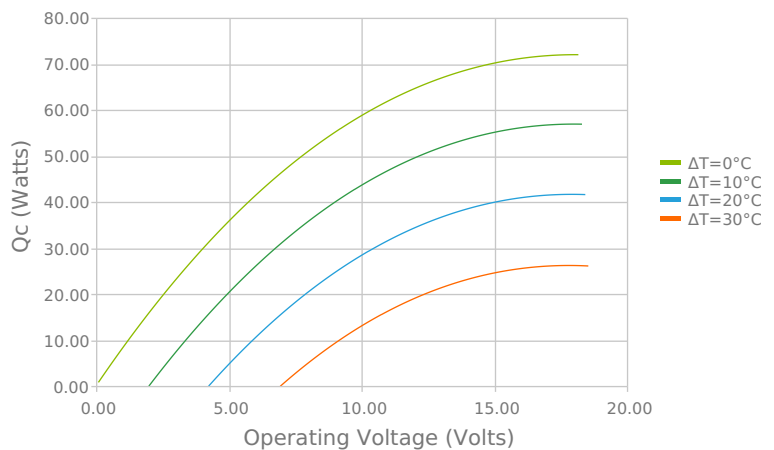

Coefficient of Performance (COP = Qc/Pin)
 Tambient = 35°C | Tcontrol = 20°C

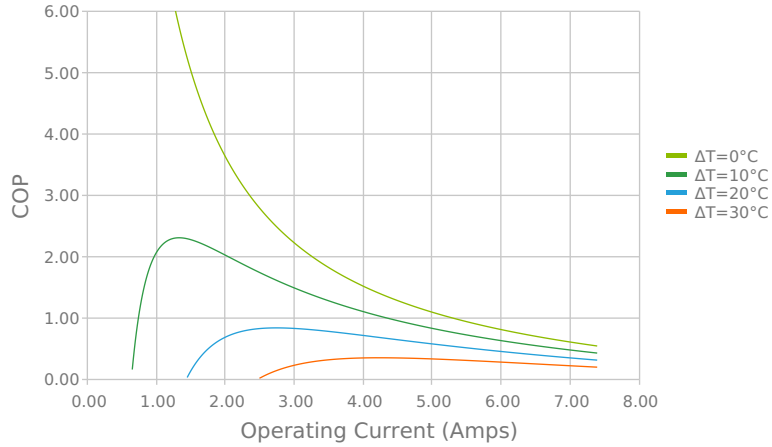

Coefficient of Performance (COP = Qc/Pin)
 Tambient = 35°C | Tcontrol = 20°C

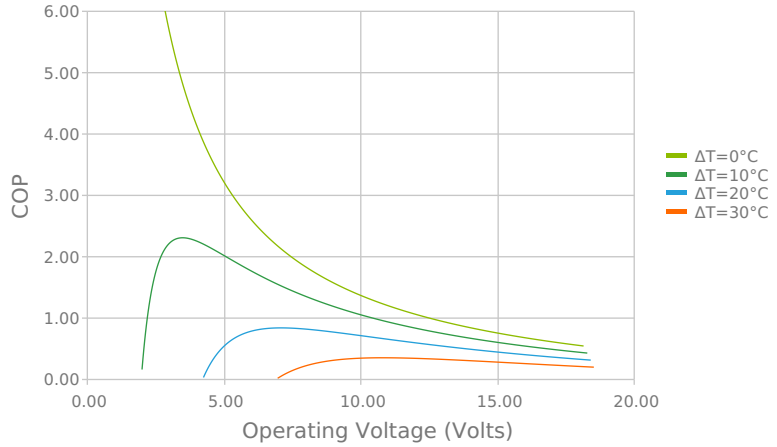

Total Heat Dissipated at Hot Side (Qh=Qc+Pin)
 Tambient = 35°C | Tcontrol = 20°C

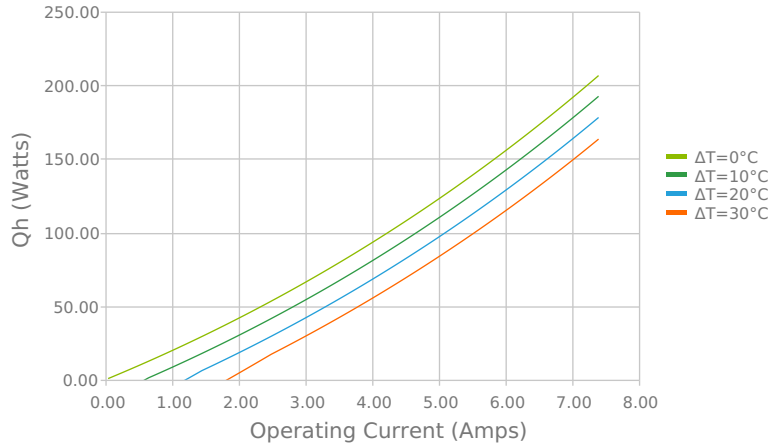

Total Heat Dissipated at Hot Side (Qh=Qc+Pin)
 Tambient = 35°C | Tcontrol = 20°C

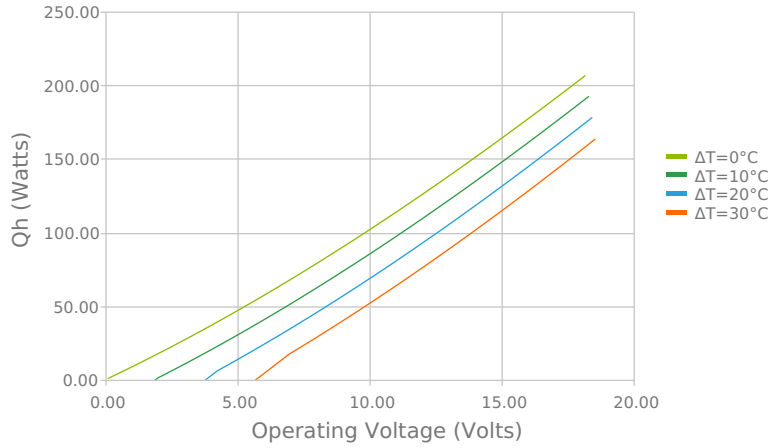

Heat Pumped at Cold Side (Qc)
 Voperating = 12.04 Volts | Ioperating = 5.12 Amps

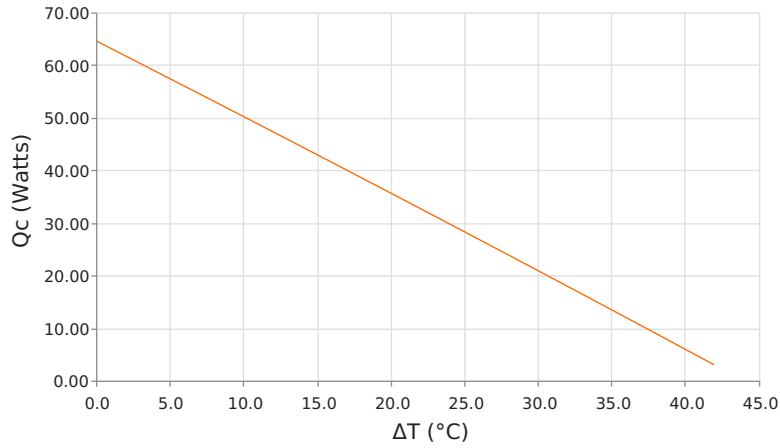

Coefficient of Performance (COP = Qc/Pin)
 Voperating = 12.04 Volts | Ioperating = 5.12 Amps

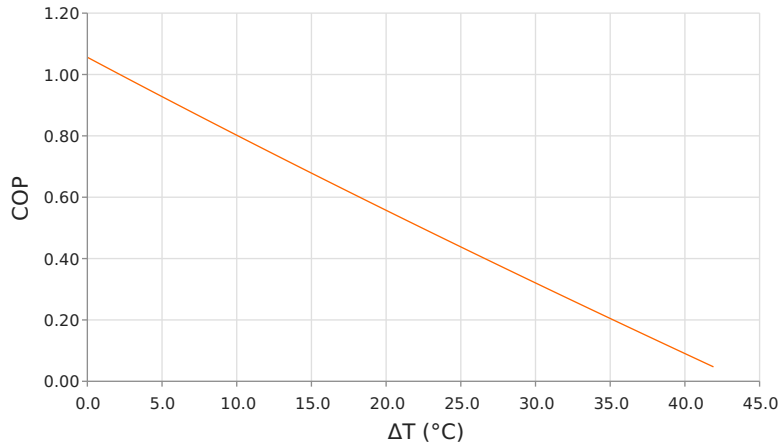

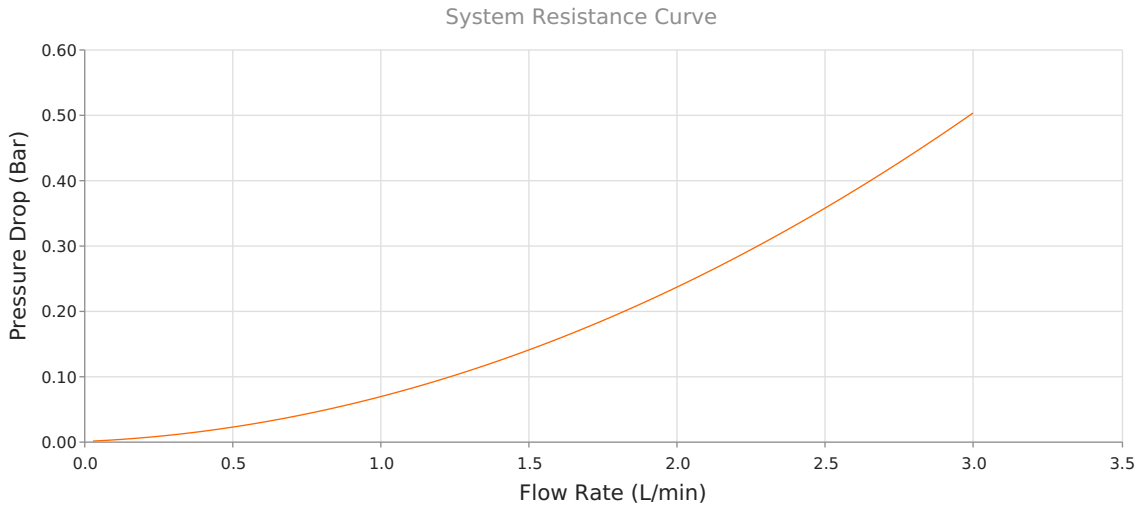

SPECIFICATIONS

- Operating Temperature Range**
- Supply Voltage**
- Current Draw**
- Power Supply**
- Performance Tolerance**
- Weight**

-40°C to 62°C
12.0 VDC nominal / 15.0 VDC maximum
3.9 A running / 4.3 A startup
56.0 Watts
10%
0.40 kg

MOUNTING HOLE LOCATION

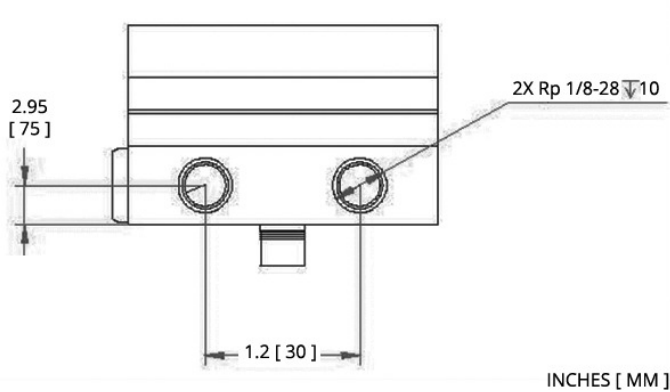

ELECTRICAL CONNECTIONS

TEM+ : Red
 TEM - : Black
 Wire Size: 20 AWG

The overheat protection (OHT) bimetal thermostat has a maximum current of 8 Amps. For systems 8 Amps or less, the thermostat can be connected directly in series with thermoelectric modules (TEMs). Otherwise connect the TEMs to the power source through a relay of suitable rating which state is controlled with the bimetal thermostat.

NOTES

¹Cold block requires insulation to minimize moisture buildup under dew point conditions.

Any information furnished by Laird and its agents, whether in specifications, data sheets, product catalogues or otherwise, is believed to be (but is not warranted as being) accurate and reliable, is provided for information only and does not form part of any contract with Laird. All specifications are subject to change without notice. Laird assumes no responsibility and disclaims all liability for losses or damages resulting from use of or reliance on this information. All Laird products are sold subject to the Laird Terms and Conditions of sale (including Laird's limited warranty) in effect from time to time, a copy of which will be furnished upon request.

© Copyright 2019-2021 Laird Thermal Systems, Inc. All rights reserved. Laird™, the Laird Ring Logo, and Laird Thermal Systems™ are trademarks or registered trademarks of Laird Limited or its subsidiaries.

Date: 06/07/2021