

Outdoor Cooler Series Thermoelectric Cooler Assembly

The AA-150-24-44 is an Air-to-Air thermoelectric cooler assembly that uses impingement flow to transfer heat. It offers dependable compact performance by cooling objects via convection. Heat is absorbed and dissipated through high density heat exchangers equipped with air ducted shrouds and brand name fans. The heat pumping action occurs from custom designed thermoelectric modules that achieve a high coefficient of performance (COP) to minimize power consumption. This model has been designed to pass rigorous Telcordia test requirements conducted by our customers such as earthquake resistance, salt, fog, wind-driven rain, high temperature exposure, and dust contaminants. This is due to the selection of world class components such as brand fans with the highest degree of environmental protection and lifetime guaranteed waterproof connectors heavy duty anodization on the high-density heat sinks overheat protection and double environmental seals for the thermoelectric modules.

Features

- Wide operating temperature range from -40°C to +55°C
- Meets Telcordia requirements
- Environmentally friendly solid-state operation
- No compressor or CFC refrigerants
- Optional bi-polar thermostatic control

Applications

- Enclosure Cooling
- Cooling for Mobile Base Stations and Cell Towers
- Thermoelectric Cooling for Outdoor Kiosks
- Thermal Management Solutions for Beverage Cooling
- Energy Storage Systems

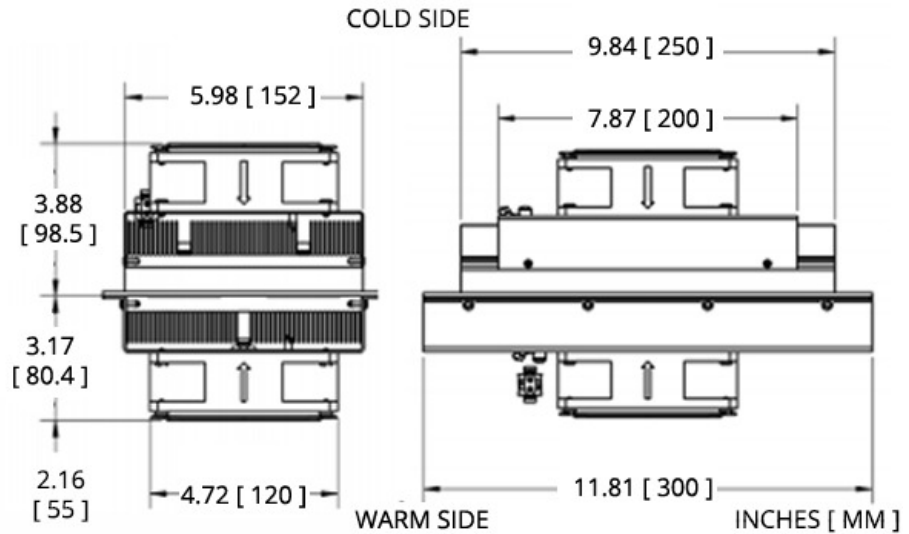

ELECTRICAL AND THERMAL PERFORMANCE

Heat Pumped at Cold Side (Qc)
 Tambient = 35°C | Tcontrol = 20°C

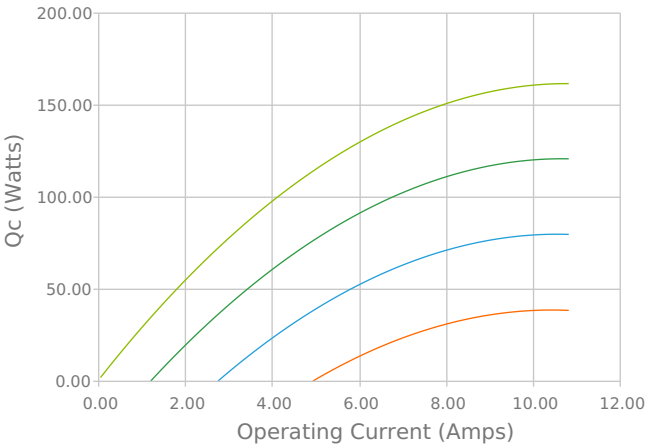

Heat Pumped at Cold Side (Qc)
 Tambient = 35°C | Tcontrol = 20°C

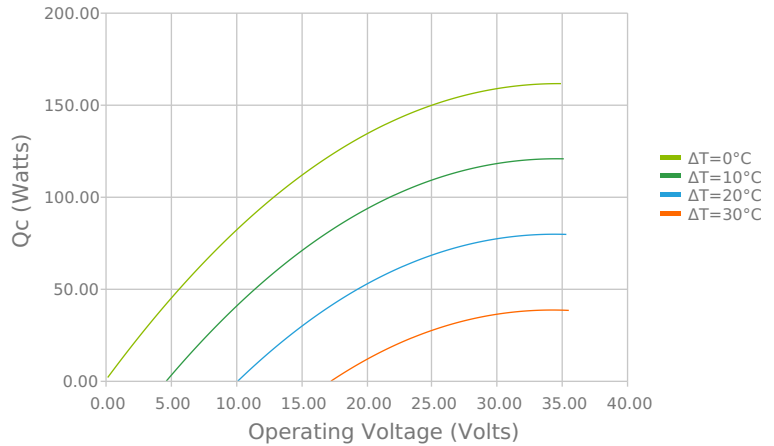

Coefficient of Performance (COP = Qc/Pin)
 Tambient = 35°C | Tcontrol = 20°C

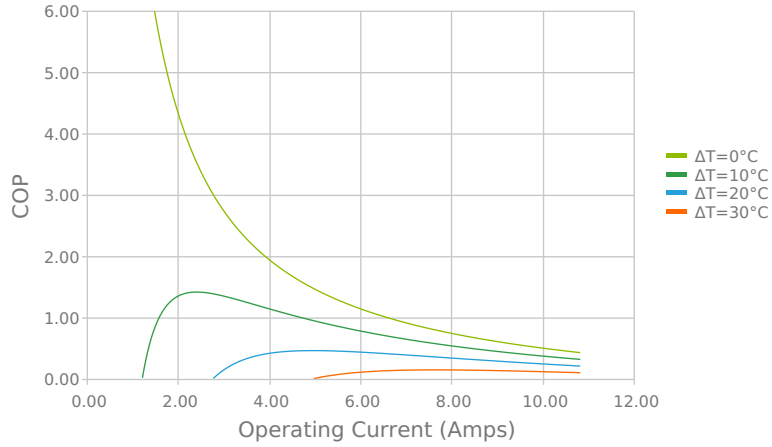

Coefficient of Performance (COP = Qc/Pin)
 Tambient = 35°C | Tcontrol = 20°C

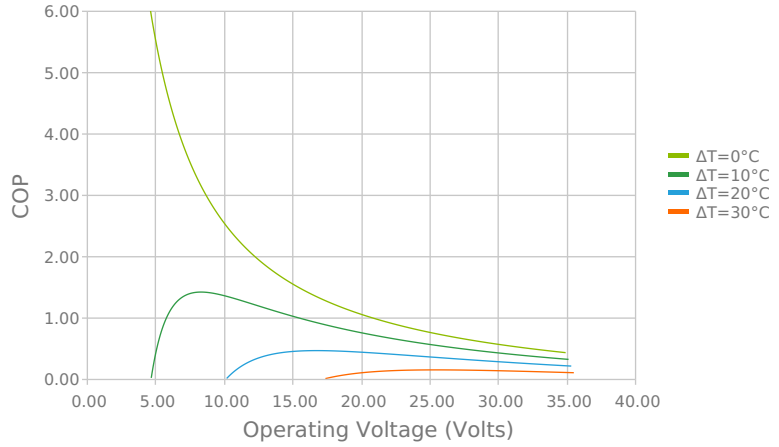

Total Heat Dissipated at Hot Side (Qh=Qc+Pin)
 Tambient = 35°C | Tcontrol = 20°C

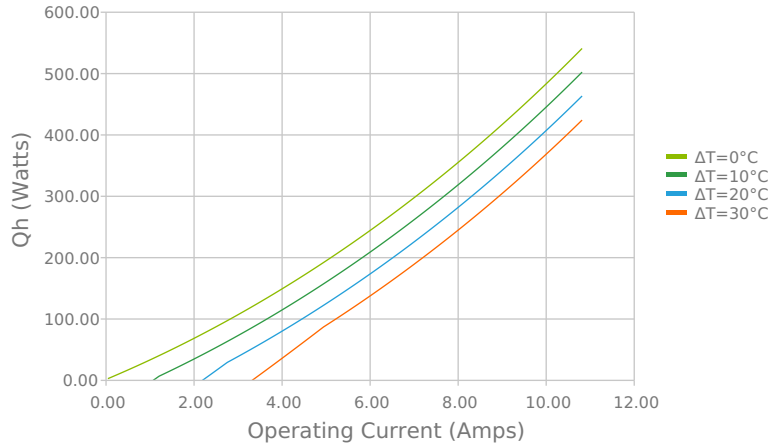

Total Heat Dissipated at Hot Side (Qh=Qc+Pin)
 Tambient = 35°C | Tcontrol = 20°C

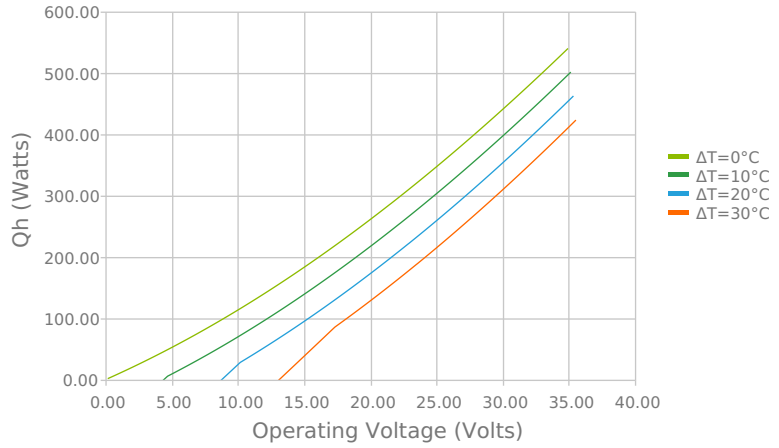

Heat Pumped at Cold Side (Qc)
 Voperating = 24.02 Volts | Ioperating = 7.59 Amps

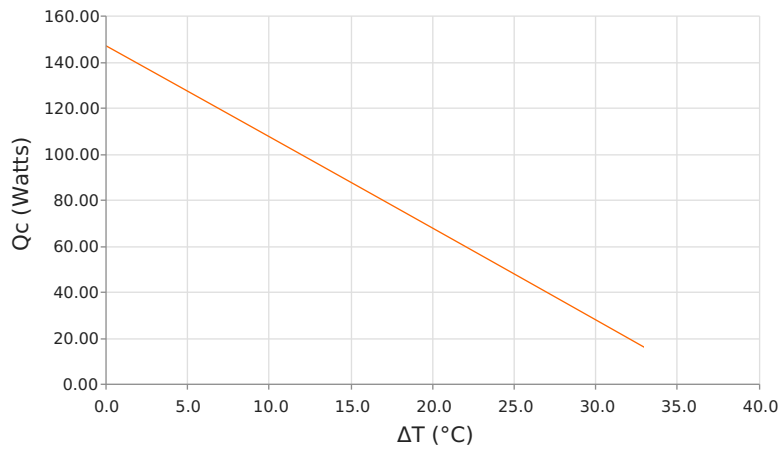

Coefficient of Performance (COP = Qc/Pin)
 Voperating = 24.02 Volts | Ioperating = 7.59 Amps

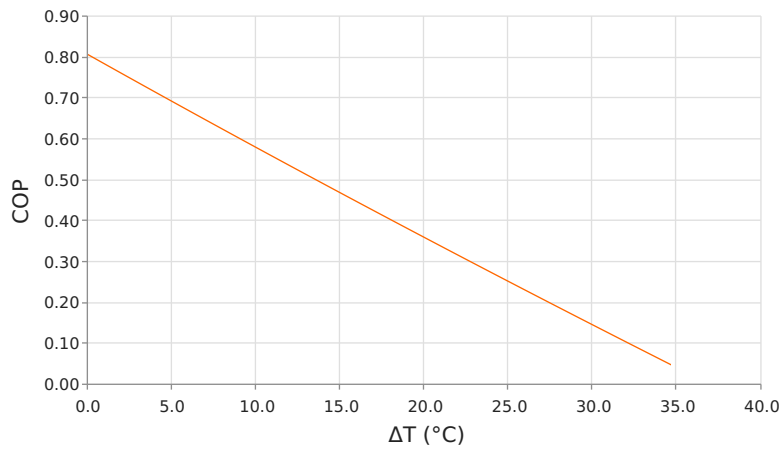

SPECIFICATIONS

- Temperature Range (External Ambient)¹**
- Temperature Range (Internal Enclosure)**
- Supply Voltage**
- Current Draw**
- Power Supply**
- Performance Tolerance**
- Fan MTBF**
- Sound Level (1 m distance)**
- Weight**

-40°C to 55°C
-20°C to 55°C
24.0 VDC nominal / 28.0 VDC maximum
7.9 A running / 10.0 A startup
190.0 Watts
10%
70,000 hours
58 dBA
5.10 kg

MOUNTING HOLE LOCATION

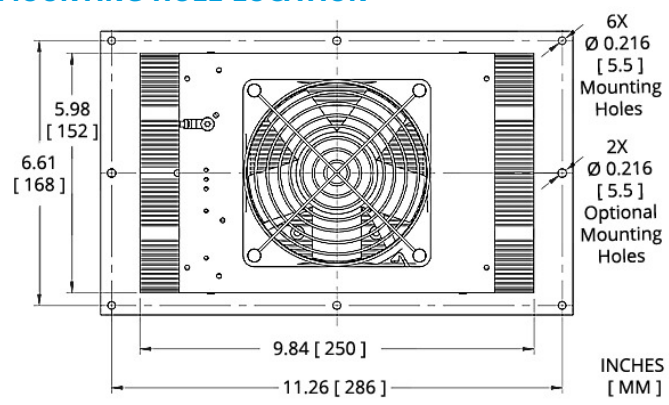

WIRING SCHEMATIC

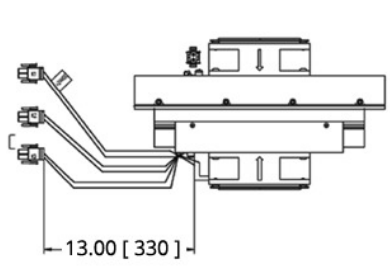

- Electrical Connections:**
- K1: Power to TEM Array (Cooling Mode)**
 P1: Positive (Red) Marked +24 VDC
 P2 Negative (Black)
 - K2: Power to Exterior Fan (Warm Side)**
 P1: Positive (Orange) +24 VDC
 P2 Negative (White)
 - K3: Power to Interior Fan (Cold Side)**
 P1: Positive (Green) +24 VDC
 P2 Negative (White)

NOTES

- ¹Controller function shall not operate the external fan during heating mode.
- ²Rating for unit without protective shroud. A higher degree of protection can be obtained with external shroud.

Any information furnished by Laird and its agents, whether in specifications, data sheets, product catalogues or otherwise, is believed to be (but is not warranted as being) accurate and reliable, is provided for information only and does not form part of any contract with Laird. All specifications are subject to change without notice. Laird assumes no responsibility and disclaims all liability for losses or damages resulting from use of or reliance on this information. All Laird products are sold subject to the Laird Terms and Conditions of sale (including Laird's limited warranty) in effect from time to time, a copy of which will be furnished upon request.

© Copyright 2019-2021 Laird Thermal Systems, Inc. All rights reserved. Laird™, the Laird Ring Logo, and Laird Thermal Systems™ are trademarks or registered trademarks of Laird Limited or its subsidiaries.

Date: 06/04/2021